

FOR OFFICIAL USE

--	--	--	--	--	--

Total
mark

--

X100/103

NATIONAL
QUALIFICATIONS
2007

TUESDAY, 15 MAY
1.55 PM – 2.50 PM

MATHEMATICS
INTERMEDIATE 1
Units 1, 2 and 3
Paper 2

Fill in these boxes and read what is printed below.

Full name of centre

--

Town

--

Forename(s)

--

Surname

--

Date of birth

Day Month Year

--	--	--	--	--	--	--	--

Scottish candidate number

--	--	--	--	--	--	--	--	--	--

Number of seat

--

- 1 You may use a calculator.**
- 2 Write your working and answers in the spaces provided. Additional space is provided at the end of this question-answer book for use if required. If you use this space, write clearly the number of the question involved.
- 3 Full credit will be given only where the solution contains appropriate working.
- 4 Before leaving the examination room you must give this book to the invigilator. If you do not you may lose all the marks for this paper.



FORMULAE LIST

Circumference of a circle: $C = \pi d$
Area of a circle: $A = \pi r^2$

Theorem of Pythagoras:

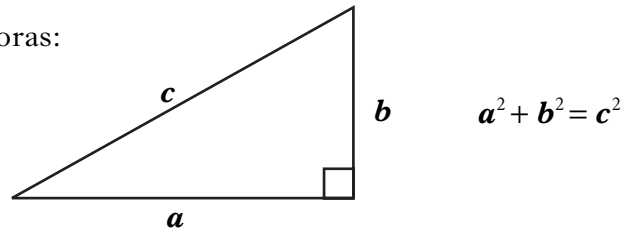

Trigonometric ratios
in a right angled
triangle:

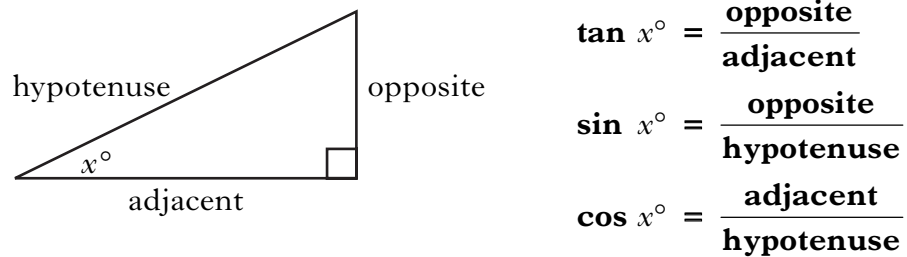

Marks

ALL questions should be attempted.

1. The bar graph shows the number of hotels in Southbay awarded grades A to E by the local tourist board.

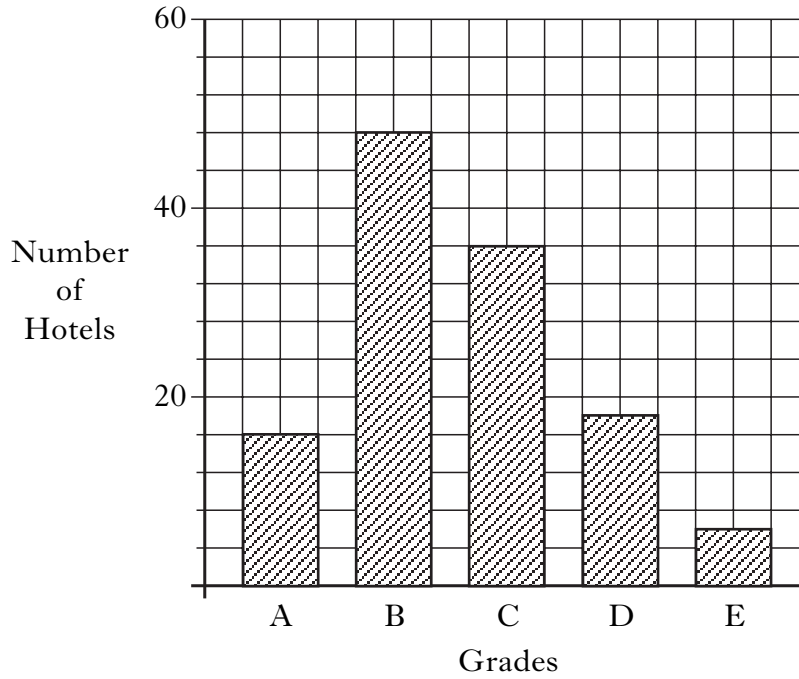

- (a) How many hotels were awarded an A grade?

1

- (b) Write down the modal grade.

1

[Turn over

Marks

2. The distance from Earth to the Sun is approximately 150 million kilometres. Write this number in standard form.

2

3. An aeroplane took off from Edinburgh at 0753 and landed in Shetland at 0908. The distance flown by the aeroplane was 295 miles. Calculate the average speed of the aeroplane in miles per hour.

3

4. Solve algebraically the equation

$$17y - 12 = 3y + 44.$$

3

Marks

5. A teacher records the number of absences and end of term test mark for each of her students.
The scattergraph shows the results.

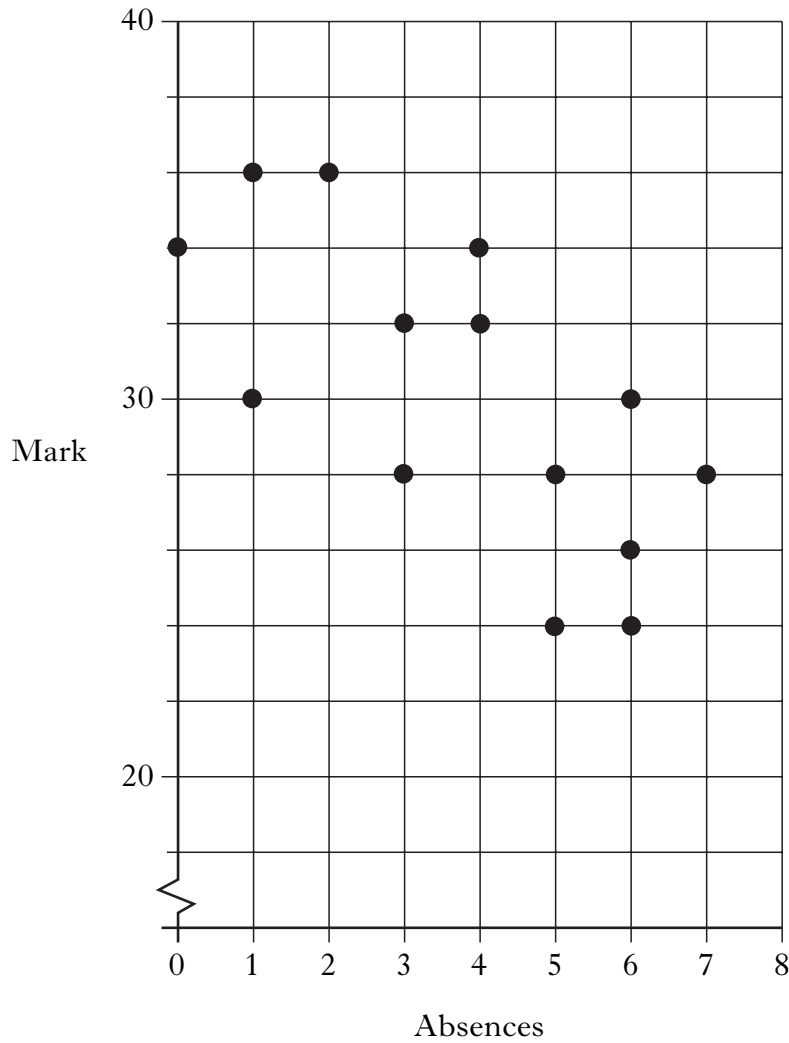

- (a) Draw a line of best fit through the points on the graph. **1**
- (b) Use your line of best fit to estimate the mark of a student who had 8 absences.

1

[Turn over

Marks

6. (a) Multiply out the brackets and simplify

$$3(5p + 3) - 2p.$$

2

(b) Factorise

$$21 - 14m.$$

2

Marks

7. The weights of two groups of ten people are to be compared.
Listed below are the weights (in kilograms) of the ten people in group A.

64 71 73 66 69 78 77 75 76 71

(a) Find the median.

2

(b) Find the range.

2

(c) For the ten people in group B the median is 76 and the range is 20.
Make **two** comments comparing the weights of the people in group A
and group B.

2

[Turn over

Marks

8. Sam invests £7600 in a bank account.

- The rate of interest is 4.8% per annum.
- The bank deducts 20% tax from the interest.

Calculate the interest Sam receives for one year after tax has been deducted.

3

Marks

9. Phil is making a wooden bed frame.

The frame is rectangular and measures 195 centimetres by 95 centimetres.

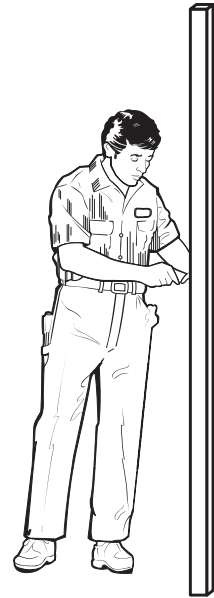
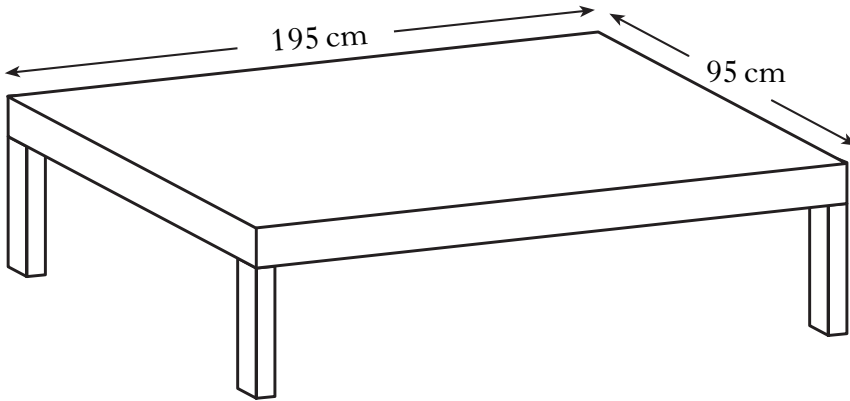

To make the frame rigid, Phil is going to add a piece of wood along one of its diagonals.

He has a piece of wood 2.2 metres long.

Is this piece of wood long enough to fit along the diagonal?

Give a reason for your answer.

Do not use a scale drawing.

4

[Turn over

Marks

10. Curtis flew from New York to London where he changed 1400 dollars into pounds. He spent £650 in London and then changed the rest into euros before travelling to Paris. How many euros did Curtis receive?

Exchange Rates	
\$	£1 = 1.75 dollars
€	£1 = 1.38 euros

3

Marks

11. Three roads form a right angled triangle as shown in the diagram.

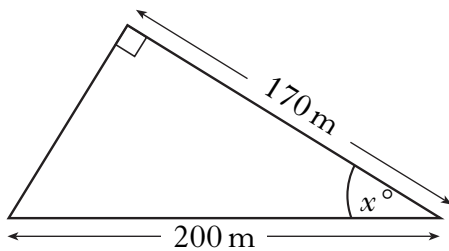
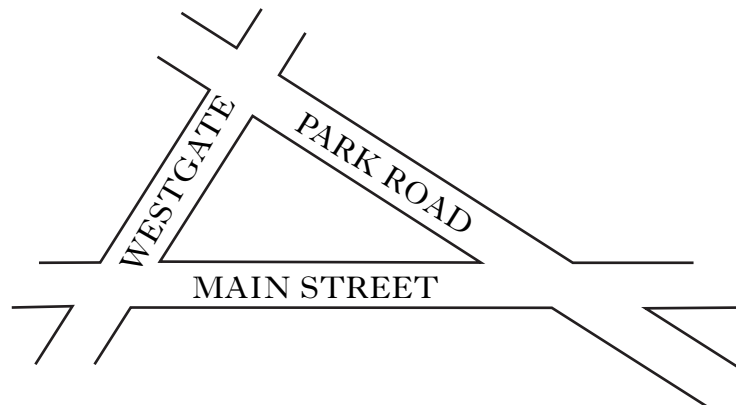

- Main Street is 200 metres long.
- Park Road is 170 metres long.
- The angle between Westgate and Park Road is 90° .

The size of the angle between Main Street and Park Road is x° .

Calculate x .

Give your answer to **one decimal place**.

4

[Turn over

Marks

12. Pamela paid £40 for a concert ticket.
She was unable to go to the concert, so she sold her ticket on the Internet for £26.
Express her loss as a percentage of what she paid for the ticket.

4

Marks

13. The diagram below shows a birthday card.

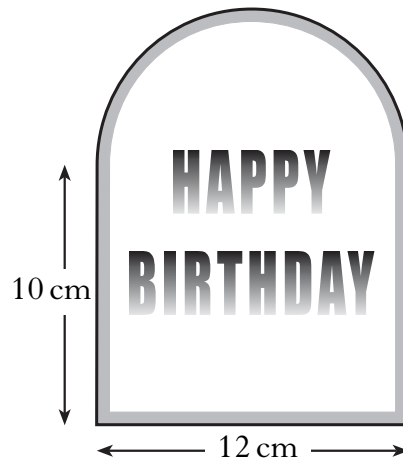

The card consists of a rectangle and a semi-circle.
There is gold ribbon all round the border of the card.
Calculate the total length of gold ribbon needed for this card.
Give your answer to the **nearest centimetre**.

5

[Turn over for Question 14 on Page fourteen

Marks

14. The tariffs shown below are available when buying a mobile phone.

<p>Pay As You Go</p> <p>Calls: 14p per minute</p>

<p>Monthly Contract</p> <p>Rental: £18 per month</p> <p>Calls: 6p per minute</p>

- (a) Find the cost of using 200 minutes of calls each month on the:
- Pay As You Go tariff;
 - Monthly Contract tariff.

2

- (b) Nick and Amy have mobile phones.
Nick is on Pay As You Go and Amy has a Monthly Contract.
In April:
- the cost to each was exactly the same
 - Nick used the same number of minutes as Amy.
- How many minutes was this?

3

[END OF QUESTION PAPER]

ADDITIONAL SPACE FOR ANSWERS

--

ADDITIONAL SPACE FOR ANSWERS

--